

Data Sheet

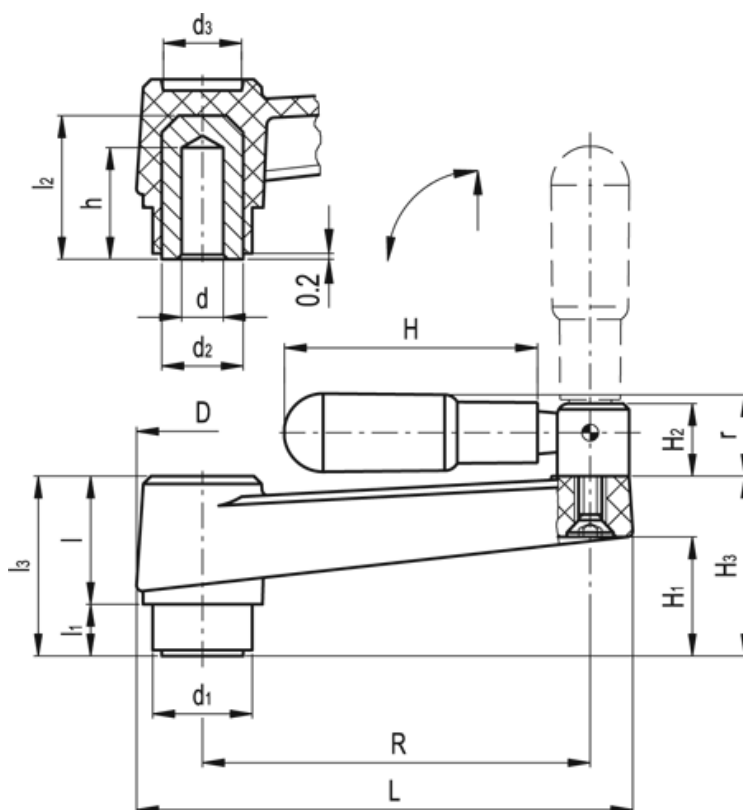

Article number: 2301044117
Description: E+G Crank handle
MT.64-AT+IR

Measures



D = 27	H2 = 14	r = 15.0
d1 = 20.0	H3 = 32.0	Weight (g) = 100
d2 = 15	L = 86	
d3 = 16	l = 23	
d H7 = 8	l1 = 9	
H = 45	l2 = 25	
h = 20	l3 = 32	
H1 = 18.5	R = 64	